

CLOW
VALVE CO.

ClowValve.com



RESILIENT WEDGE GATE VALVES

4" THROUGH 20"

MODEL 2638

AWWA C515 250 PSI • UL/FM APPROVED 200 PSI • NSF
61 CERTIFIED • FULL WATER WAY • FUSION BONDED
EPOXY COATED • 10 YEAR LIMITED WARRANTY



Clow Valve, A Division of McWane, Inc.

For Generations

RESILIENT WEDGE VALVE

In 1975, Clow recognized the increased requirements and escalating maintenance cost of water systems in the United States.

Clow responded by introducing the first R/W (Resilient Wedge) Gate Valve in America. This introduction revolutionized the valve market in the U.S.

Clow was the first to introduce and still leads in the design and technical development of the bubble-tight resilient seating valve.

The Clow Resilient Wedge Valve, with its unique features and benefits, was the first to be manufactured with both AWWA and UL/FM approval for all water system requirements.

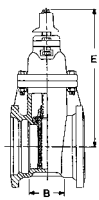

F-6100
MECHANICAL JOINT
4" – 20"

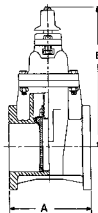

F-6102
FLANGED
4" – 20"

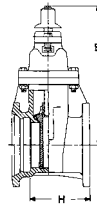

F-6106
FLANGED X MECHANICAL JOINT
4" – 20"

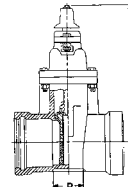

F-6110
PUSH ON FOR SDR PVC
4" – 12"

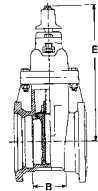

F-6111
MECHANICAL CUTTING IN JOINT
4" – 12"

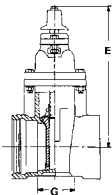

F-6112
TYTON ENDS FOR D.I. AND C900 PVC PIPE
4" – 16"

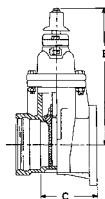

F-6113
FLANGED X TYTON
4" – 12"

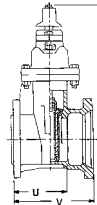

F-6114
MECHANICAL JOINT FOR TAPPING
4" – 20"

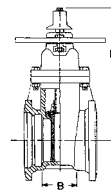

F-6120
MECHANICAL JOINT POST INDICATOR VALVE
4" – 16"

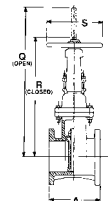

F-6136
FLANGED OS&Y
4" – 16"

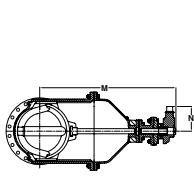

BEVEL GEARING
HORIZONTAL INSTALLATION
ALL END STYLES
14" – 20"

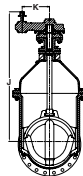

SPUR GEARING
VERTICAL INSTALLATION
ALL END STYLES
14" – 20"

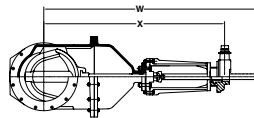

OS&Y BEVEL GEARING
HORIZONTAL INSTALLATION
ALL END STYLES
14" – 20"

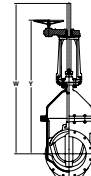

OS&Y SPUR GEARING
VERTICAL INSTALLATION
ALL END STYLES
14" – 20"

VALVE SIZE	A	B	C	E	G	H	J	K	M	N	P	Q	R	S	U	V	NO GEAR*	GEARED*	W	X	Y
4"	9	4-1/2	6-3/4	14-3/4	4-5/8	6-3/4	-	-	-	-	4-1/2	22-3/4	18-1/4	10	6-3/4	9-1/4	13-1/2	-	-	-	-
6"	10-1/2	5-1/2	7-7/8	19	5-1/4	8	-	-	-	-	5	30-1/8	23-3/4	12	8	10-1/2	19-1/2	-	-	-	-
8"	11-1/2	8-1/8	8-1/2	22-1/2	5-5/8	9-3/4	-	-	-	-	5-1/2	37-3/4	29-1/4	14	10-3/4	13-1/4	25-1/2	-	-	-	-
10"	13	10-1/2	10	26-1/2	7	11-3/4	-	-	-	-	7	45-3/4	35-3/8	18	11-3/4	14-7/8	31-1/2	-	-	-	-
12"	14	10-3/4	11-1/4	30	8-1/2	12-7/8	-	-	-	-	8-1/2	53-1/8	40-3/8	18	12-3/8	15	37-3/4	-	-	-	-
14"	15	10	-	37-3/4	10-1/2	13-1/2	52-1/8	8	48-5/8	9-1/8	-	74-3/4	59-3/4	22	13-1/4	16-3/4	52	100	76	59-7/8	64-1/2
16"	16	10	-	37-3/4	10-1/2	13	51-1/8	8	47-5/8	9-1/8	-	74-3/4	59-3/4	22	12-3/4	16-1/4	52	100	76	59-7/8	64-1/2
18"	17	11-3/4	-	-	-	14-7/8	58	12	55-3/4	10-1/8	-	-	-	-	14-5/8	18-1/8	-	189	90-7/8	70-1/8	74-5/8
20"	18	11	-	-	-	14-1/2	57	12	54-3/4	10-1/8	-	-	-	-	14-1/2	18	-	189	90-7/8	70-1/8	74-5/8

NOTE: It is recommended that valves be installed with stems vertical when used in raw sewage, or sludge applications, or in water with excessive sediment. Flanged end connections are not recommended for buried service. * No. of turns to full open

ENGINEERING FEATURES

THRUST BEARINGS

Delrin thrust bearings above and below the thrust collar reduce friction and minimize operating torque.

STAINLESS STEEL HARDWARE

Stainless steel nuts and bolts provide long-life corrosion protection.

COPPER ALLOY STEM

Long, trouble-free life with high strength, non-corrosive copper alloy stem and stem nut.

100% COATED WEDGE

100% coated wedge ensures bubble-tight seal every time up to 250 PSI. With twin seal design.

ELLIPTICAL BOLT HOLES

Hole design on MJ connection eliminates the need for anti-rotation bolts.

EASY STORAGE

Pads on the bottom of all valves keep valve in upright position for easier storage and protection from the elements.

LIFTING LUG

Integrated lifting lugs on follower plate for setting the valve into position. Available 4"–16".



REPLACEABLE O-RINGS

Two O-ring seals are replaceable with the valve fully open and subjected to full-rated working pressure.

NO FLAT GASKETS

O-ring seals at the stuffing box and at the bonnet to body flanges ensure the best possible seal.

MINIMAL FLOW LOSS

Smooth, unobstructed waterway is free of pockets, cavities, and depressions allowing for minimal flow loss and lower pumping costs. All valves accept full size tapping cutter.

EPOXY COATING

Clow corrosion resistant fusion-bonded epoxy coating, conforming to AWWA C550 and NSF 61 Certified, protects both inside and outside of valve.

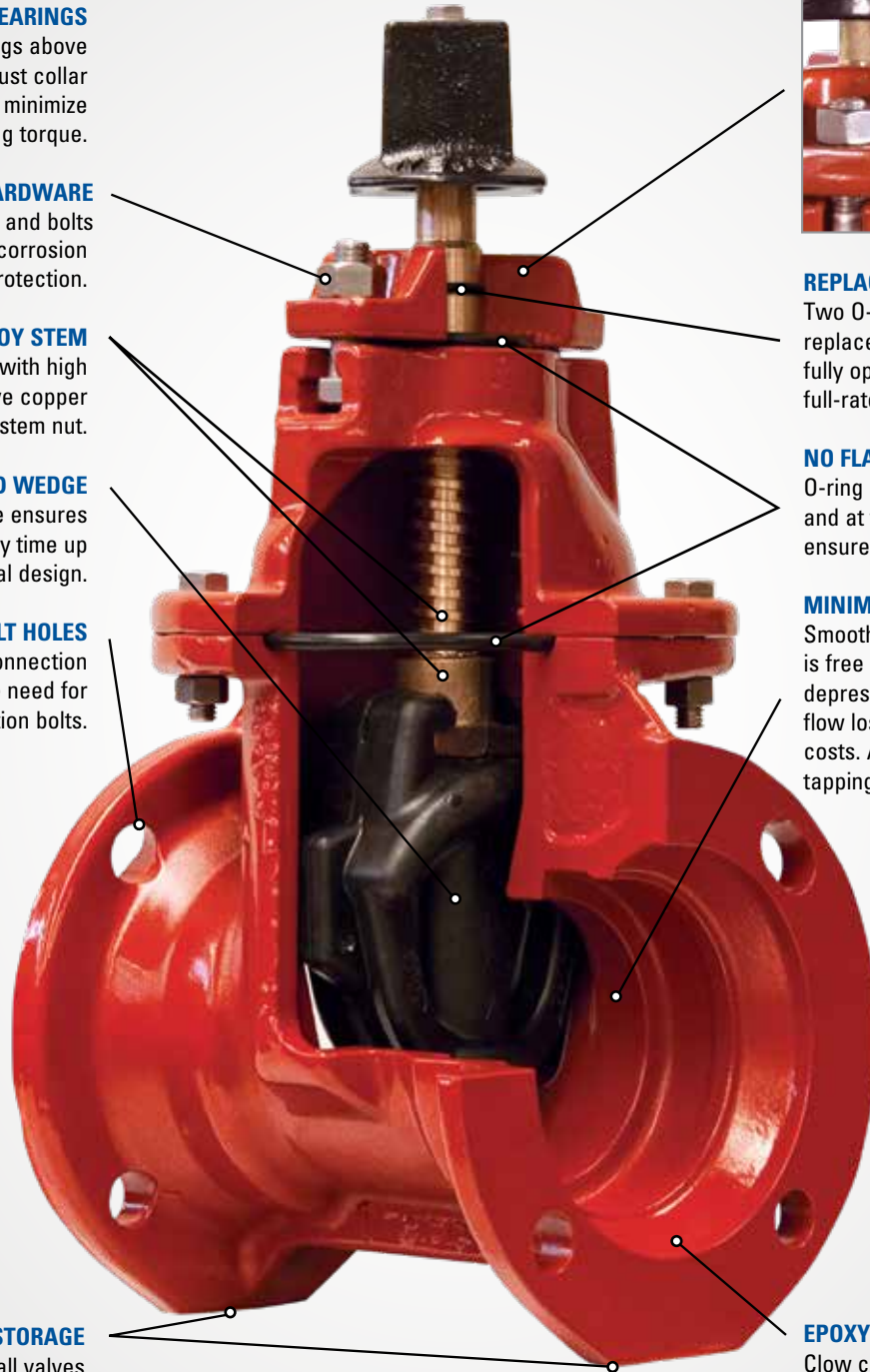

VALVE RATING: All valves are rated at 250 PSI for AWWA service and hydrostatically tested to 500 PSI.

All 4"–12", 18" and 20" valves are rated at 200 PSI for UL/FM service. All 14" and 16" valves are rated at 250 PSI for UL/FM service.

RECOMMENDED SPECIFICATIONS

1. Valves shall conform to the latest revision of AWWA Standard C515 covering resilient seated gate valves for water supply service.
2. The valves shall have a ductile iron body, bonnet, and O-ring plate. The wedge shall be totally encapsulated with rubber.
3. The sealing rubber shall be permanently bonded to the wedge per ASTM D429.
4. Valves shall be supplied with O-ring seals at all pressure retaining joints. No flat gaskets shall be allowed.
5. The valves shall be either non-rising stem or rising stem, opening by turning left or right, and provided with 2" square operating nut or a handwheel with the word "Open" and an arrow to indicate the direction to open.
6. Stems shall be cast copper alloy with integral collars in full compliance with AWWA. All stems shall operate with copper alloy stem nuts independent of wedge and of stem (in NRS valves).
7. Stems shall have two O-rings located above thrust collar and one O-ring below. Stem O-rings shall be replaceable with valve fully opened and subjected to full pressure. The stems on 4" – 20" shall also have two low torque thrust bearings located above and below the stem collar to reduce friction during operation.
8. Waterway shall be smooth, unobstructed and free of all pockets, cavities and depressions in the seat area. Valves 4" and larger shall accept a full size tapping cutter.
9. The body, bonnet and O-ring plate shall be fusion-bonded epoxy coated, both interior and exterior on body and bonnet. Epoxy shall be applied in accordance with AWWA C550 and be NSF 61 Certified.
10. Each valve shall have maker's name, pressure rating, country of origin, and year in which it was manufactured cast in the body. Prior to shipment from the factory, each valve shall be tested by hydrostatic pressure equal to the requirements of AWWA C515 (and UL/FM where applicable).
11. Valves shall have all component parts cast and assembled in the USA and shall be manufactured by the Clow Valve Company.

COMMITTED TO ENVIRONMENTAL RESPONSIBILITY

Clow Valve Company is committed to protecting our natural resources through environmentally responsible manufacturing practices, including the use of 80+% recycled content in our hydrants and valves.



CLOW
VALVE CO.

902 South 2nd Street
Oskaloosa, IA 52577
Ph 641-673-8611
Fx 641-673-8269



POCKET ENGINEER
Available for iOS + Android
or online at pe.mcwane.com.



*PATENT PENDING
REVISION B-2022



ClowValve.com

CLOW
VALVE CO.

ClowValve.com

**LARGE
RESILIENT
WEDGE GATE
VALVES
24" THROUGH 54"
MODEL 2638**

AWWA C515 250 PSI • NSF 61 CERTIFIED • AWWA
C550 EPOXY COATED • 10 YEAR LIMITED WARRANTY

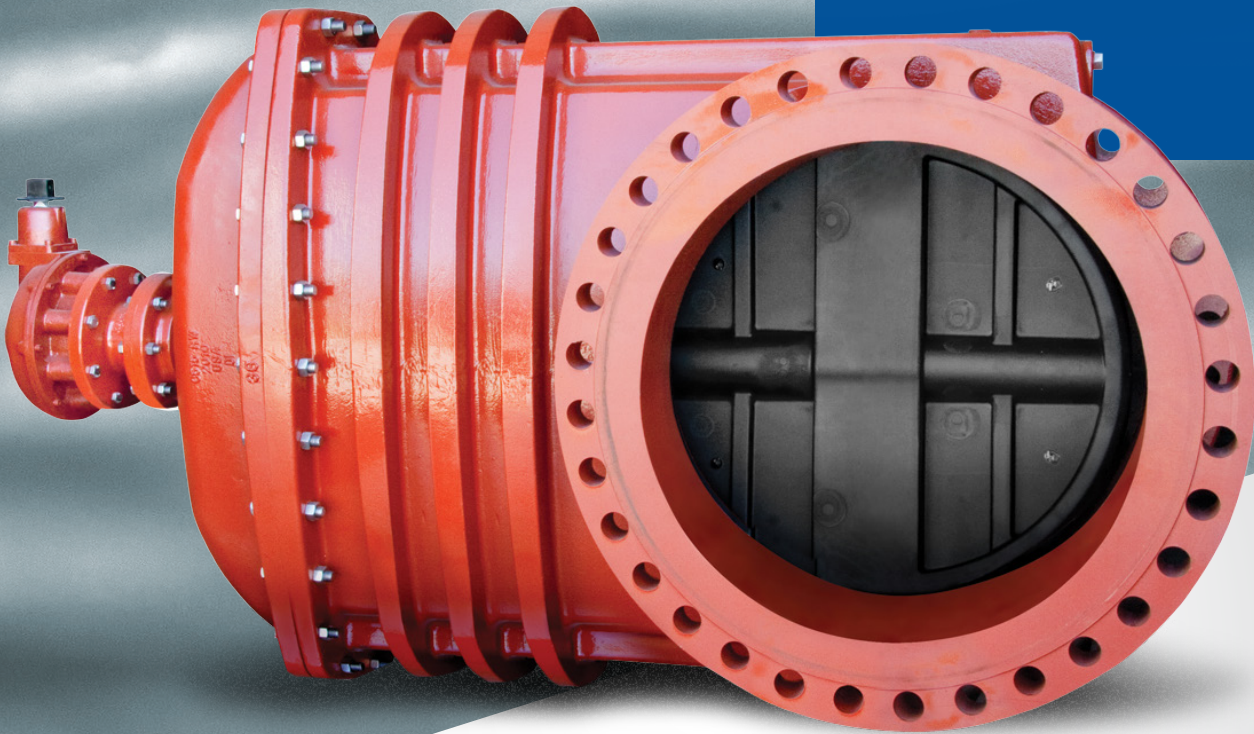

Clow Valve is a division of McWane, Inc.

For Generations

LARGE R/W GATE VALVES

Resilient wedge valves and resilient wedge gate valves from Clow bring the latest technology and more than a century of engineering expertise to your water system. They're designed to meet or exceed AWWA standards and have, for decades, been recognized as the original and definitive standard. Trust your water system to the durability and precision engineering of resilient wedge gate valves from Clow.

RESILIENT WEDGE GATE VALVE WITH CLEANTRACK™ TECHNOLOGY

In America today, systems are increasing their demand for larger-sized water lines. With these growing demands, Clow has made the commitment to meet, and surpass, previous large resilient seated gate valve requirements with a new concept — CleanTrack™ technology.

Sediment buildup in valves has been a costly proposition since the first water valves were created. In years past, systems with sediment-laden valves faced time consuming and costly valve removal or repair. Advanced large double disc technologies of decades past used various methods to clear the line of debris prior to closing.

Clow's 24"–54" gate valves have taken the best of the century-old double disc design and integrated it with the best of the latest resilient seated gate valve design and technology, to create valves with CleanTrack™ technology. CleanTrack™ uses a unique roller-scraper system that automatically cleans the track in the valve body when the valve is closing. Less sediment buildup makes for improved performance which means reduced maintenance and lower potential replacement costs.

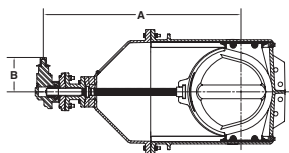

**ALL END STYLE BEVEL GEARING
HORIZONTAL INSTALLATION**
24"–54"

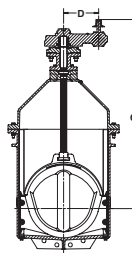

**ALL END STYLE SPUR GEARING
VERTICAL INSTALLATION**
24"–54"

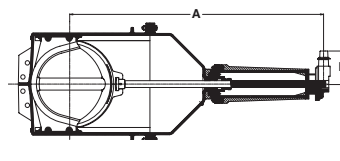

**ALL END STYLE OS&Y
BEVEL GEARING HORIZONTAL
INSTALLATION**
24" ONLY

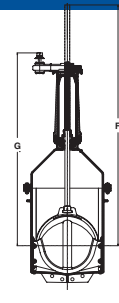

**ALL END STYLE OS&Y
BEVEL GEARING VERTICAL
INSTALLATION**
24" ONLY

VALVE SIZE	A	B	C	D	E	F	G	NO. OF TURNS TO FULL OPEN	GEAR RATIO
24"	60-1/4	10-3/8	62-5/8	12	79-1/8	140-5/8	83-3/4	228	3 to 1
30"	71-3/8	14-7/8	80	14	-	-	-	588	6 to 1
36"	81-1/16	14-7/8	89-11/16	14	-	-	-	684	6 to 1
42"	98-3/8	17	108-1/2	16	-	-	-	800	8 to 1
48"	101-3/8	17	111-1/2	16	-	-	-	800	8 to 1
54"	101-3/8	17	111-1/2	16	-	-	-	800	8 to 1

NOTE: It is recommended that valves be installed with stems vertical when used in raw sewage, or sludge applications, or in water with excessive sediment. Flanged end connections not recommended for buried service. **NOTE:** 6" bypass valves are available on 36" gate valves; 4" bypass valves are available on 30" and 48"–54" gate valves; 8" bypass valves are available on 42" gate valves

ENGINEERING FEATURES

100% COATED WEDGE

100% coated wedge ensures bubble-tight seal every time up to 250 PSI. With twin seal design.

STAINLESS STEEL HARDWARE

Stainless steel nuts and bolts provide long-life corrosion protection.

BRONZE STEM

Long, trouble-free life with high strength, non-corrosive bronze stem and stem nut.

THRUST BEARINGS

Derlin thrust bearings above and below the thrust collar reduce friction and minimize operating torques.

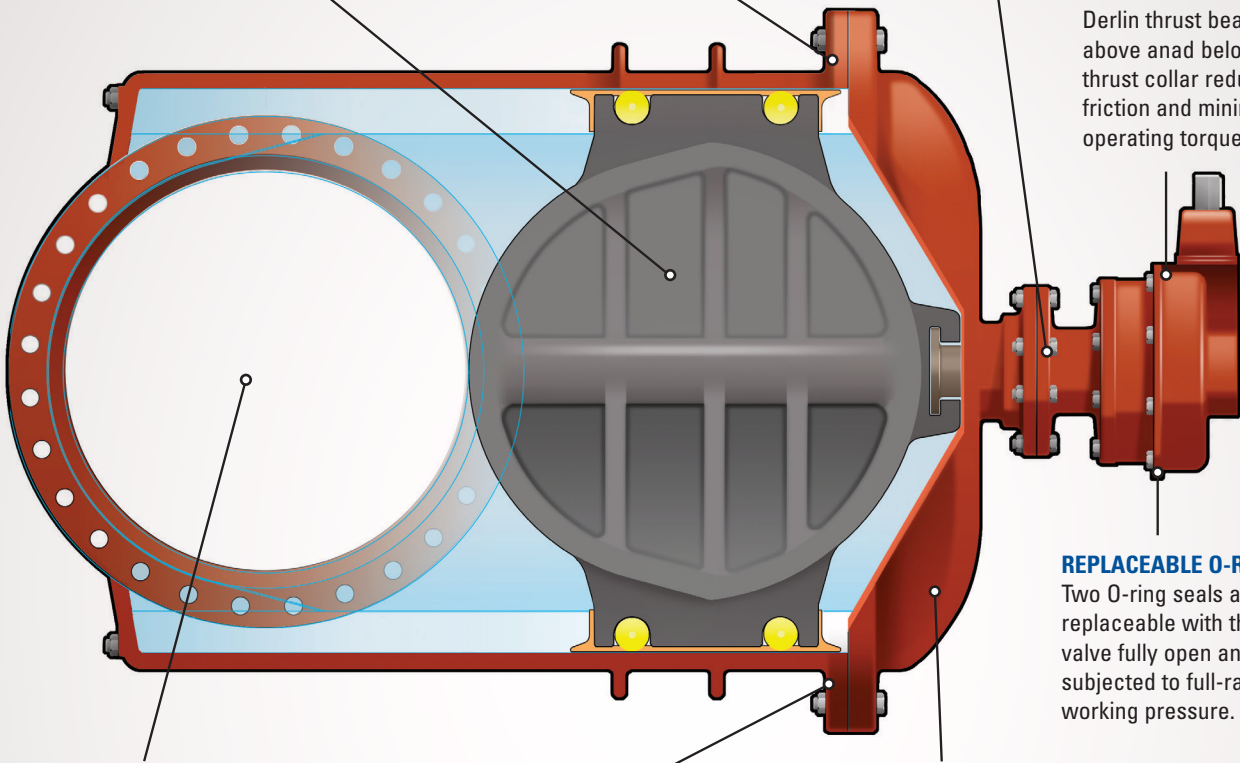

REPLACEABLE O-RINGS

Two O-ring seals are replaceable with the valve fully open and subjected to full-rated working pressure.

ACCEPT TAPPING CUTTER

Valves accept full-size tapping cutter (24"–48").

NO FLAT GASKETS

O-ring seals at stuffing box and bonnet to body flanges ensures the best possible seal. There are no flat gaskets.

EPOXY COATING

Corrosion resistant fusion-bonded epoxy coating, conforming to AWWA C550 and NSF 61 Certified, protects both inside and outside of valve.

CLEANTRACK™ TECHNOLOGY

BRONZE SCRAPER

Bronze scraper affixed to resilient wedge wing is designed for long life performance.

STAINLESS STEEL TRACK

316 stainless steel track for corrosion and wear resistance.

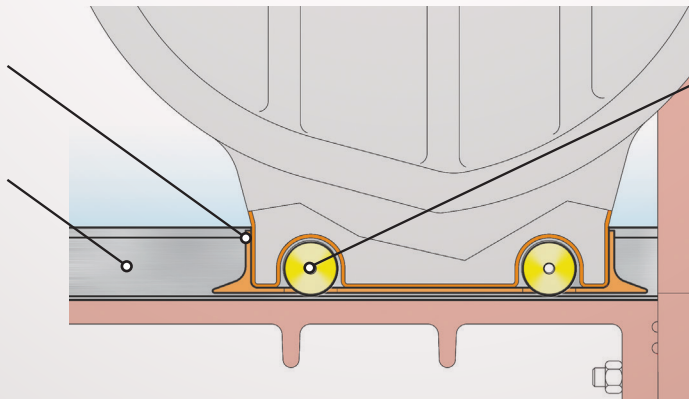

BRONZE ROLLERS

Rollers integrated into scraper protect valve body from damage.

RECOMMENDED SPECIFICATIONS

1. Valves shall conform to AWWA Standard C515 covering Resilient Seated Gate Valves for Water Supply Service, and be rated for 250 PSIG cold water working pressure.
2. The valves shall have a ductile iron body, bonnet, and stuffing box. The wedge shall be ductile iron and totally encapsulated with rubber.
3. The sealing rubber shall be permanently bonded to the wedge per ASTM D429.
4. Valves shall be supplied with O-ring seals at all pressure retaining joints. No flat gaskets or conventional type packing shall be allowed on NRS valves.
5. The valves shall be non-rising stem, opening by turning clockwise or counter-clockwise, and provided with a 2" square operating nut or a handwheel.
6. Stems for NRS assemblies shall be copper alloy with integral collars in full compliance with AWWA. Stems shall operate with copper alloy stem nuts independent of wedge and of stem. NRS stems shall have two O-rings located above thrust collar and two O-rings below. Stem O-rings above the thrust collar shall be replaceable with valve fully opened and subjected to full pressure. The stems shall also have one low-torque thrust bearing located above and one below the stem collar to reduce friction during operation.
7. 24"-48" valves shall accept a full size tapping cutter.
8. The body, bonnet and stuffing box shall be epoxy coated, both interior and exterior. Epoxy shall be applied in accordance with AWWA C550 and be NSF 61 Certified.
9. Each valve shall have maker's name, pressure rating, and year in which it was manufactured cast in the body. Prior to shipment from the factory, each valve shall be tested by hydrostatic pressure equal to the requirements of AWWA C515.
10. Valves shall be provided with bevel gears (horizontal) or spur gears (vertical) as indicated.
11. Valves in sizes 30" and larger shall have brass bushings where the stem passes through the bonnet.
12. All external bolting materials shall be stainless steel and have hexagonal heads.
13. All valves shall include CleanTrack™ Technology. CleanTrack™ consists of bronze rollers housed in a bronze scraper on the both sides of the wedge, traveling in a 316 stainless steel track.
14. Valves shall have component parts cast, machined, assembled, and tested in the USA and shall be Clow Valve, Oskaloosa, Iowa.

COMMITTED TO ENVIRONMENTAL RESPONSIBILITY

Clow Valve Company is committed to protecting our natural resources through environmentally responsible manufacturing practices, including the use of 80+% recycled content in our hydrants and valves.



ISO 9001:2015 Certified

Clow
VALVE CO.

902 South 2nd Street
Oskaloosa, IA 52577
Ph 641-673-8611
Fx 641-673-8269



POCKET ENGINEER
Available for iOS + Android
or online at pe.mcwane.com.



REVISION A-2023



ClowValve.com